

Stack-O-Matic™
CROSLEY®

CR85

1960'S Stack-O-Matic Collegiate

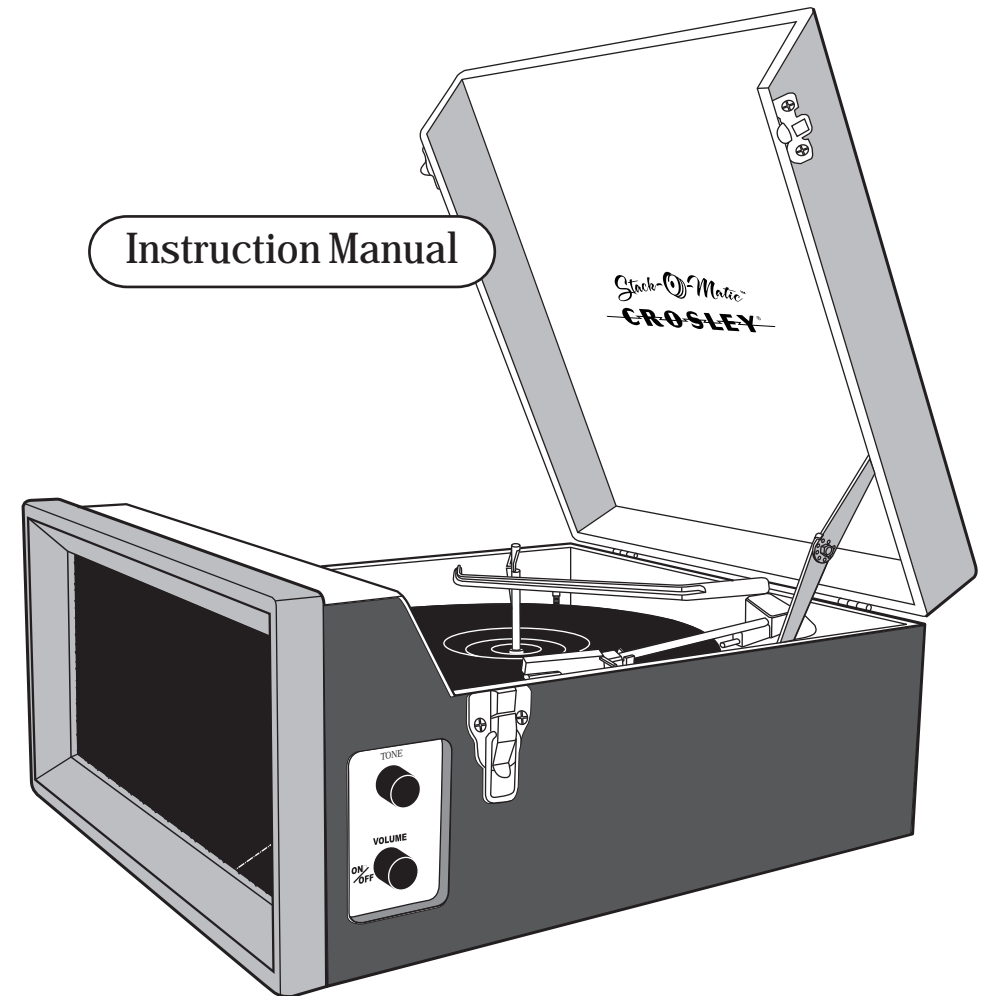

WARRANTY

Crosley Radio Products are warranted against defects in material and workmanship for a period of 90 days beginning from the date of sale to the original purchaser.

Should the unit fail under normal usage during the 90 day warranty period, a request for RETURN AUTHORIZATION (R.A.) must be made by the original customer before returning the unit. Call Crosley Radio customer service for Return Authorization at (502) 583-4246 from 9 AM to 5 PM (EST) Monday to Friday.

Upon receiving the RETURN AUTHORIZATION number from the Customer Service Department, properly pack your unit in its original packaging. Include any adapters, parts, & accessories which were originally provided with the product, along with a check or money order for \$19.95 made out to Crosley Radio to cover the handling and return postage. Display the R.A. # on the outside of the carton and ship PREPAID via standard UPS or its equivalent.

**CROSLEY
RADIO**

ATTN: RETURNS DEPT
2001 PRODUCTION DRIVE
BAY 2 & 3
LOUISVILLE, KY 40299

CROSLEY RADIO assumes no responsibility for units sent without prior Return Authorization.

The purchaser's bill of sale is the only proof of warranty entitlement and must accompany the unit.

The warranty does not cover damage due to acts of nature, accident, misuse, abuse, negligence, commercial use or modification of, or to any part of the product. This warranty does not cover damage due to improper operation or maintenance, connection to improper voltage supply, or attempted repair by anyone other than a facility authorized by Crosley Radio to service the product. This warranty does not cover products sold AS IS or consumables (such as fuses or batteries). This warranty is valid only in the United States.

This warranty gives the purchaser specified legal rights in addition to any rights which may vary from state to state.

In accordance with the "Moss-Magnuson Warranty Act" of July 10, 1975, this is termed a "limited warranty" which in no way compromises Crosley Radio, high standards of Quality and Workmanship.

IMPORTANT SAFETY INSTRUCTION

PLEASE READ CAREFULLY ALL THE FOLLOWING IMPORTANT SAFEGUARDS THAT ARE APPLICABLE TO YOUR EQUIPMENT

1. Read Instructions - All the safety and operating instructions should be read before the product is operated.
2. Retain instructions - The safety and operating instructions should be retained for future reference.
3. Heed Warnings - All warnings on the product and in the operating Instructions should be adhered to.
4. Follow Instructions - All operating and use instructions should be followed.
5. Cleaning - Unplug this product from the wall outlet before cleaning. Do not use liquid cleaners or aerosol cleaners. Use a damp cloth for cleaning.
6. Attachments - Do not use attachments not recommended by the product manufacturer as they may cause hazards.
7. Water and Moisture - Do not use this product near water - for example, near a bath tub, wash bowl, kitchen sink, or laundry tub; in a wet basement; or near a swimming pool; and the like.
8. A product and cart combination should be moved with care. Quick stops, excessive force, and uneven surfaces may cause the product and cart combination to overturn.
9. Ventilation - Slots and openings in the cabinet are provided for ventilation and to ensure reliable operation of the product and to protect it from overheating, and these openings must not be blocked or covered. The openings should never be blocked by placing the product on a bed, sofa, rug, or other similar surface. This product should not be placed in a built - in installation such as a bookcase or rack unless proper ventilation is provided or the manufacturer's instructions have been adhered to.
10. Power Sources - This product should be operated only from the type of power source indicated on the marking label, if you are not sure of the type of power supply to your home. Consult your product dealer or local power company. For products intended to operate from battery power, or other sources, refer to the operating instructions.
11. Grounding or Polarization - This product may be equipped with a polarized alternating-current line plug (a plug having one blade wider than the other). This plug will fit into the power outlet only one way. This is a safety feature. If you are unable to insert the plug fully into the outlet try reversing the plug. If the plug should still fail to fit, contact your electrician to replace your obsolete outlet. Do not defeat the safety purpose of the polarized plug.
12. Power - Cord Protection - Power - supply cords should be routed so that they are not likely to be walked on or pinched by items placed upon or against them, paying particular attention to cords at plugs, convenience receptacles, and the point where they exit from the product.
13. Lightning - For added protection for this product during a lightning storm, or when it is left unattended and unused for long periods of time, unplug it from the wall outlet and disconnect the antenna or cable system. This will prevent damage to the product due to lightning and power - line surges.
14. Power Lines - An outside antenna system should not be located in the vicinity of overhead power lines or other electric light or power circuits, or where it can fall into such power lines or circuits. When installing an outside antenna system, extreme care should be taken to keep from touching such power lines or circuits as contact with them might be fatal.
15. Overloading - Do not overload wall outlets, extension cords, or integral convenience receptacles as this can result in a risk of fire or electric shock.
16. Object and Liquid Entry - Never push objects of any kind into this product through openings as they may touch dangerous voltage points or short - out parts that could result in a fire or electric shock. Never spill liquid of any kind on the product.
17. Servicing - Do not attempt to service this product yourself as opening or removing covers may expose you to dangerous voltage or other hazards. Refer all servicing to qualified service personnel.
18. Damage Requiring Service - Unplug this product from the wall outlet and refer servicing to qualified service personnel under the following conditions:
 - a. When the power-supply cord or plug is damaged.
 - b. If liquid has been spilled, or objects have fallen into the product.
 - c. If the product has been exposed to rain or water.
 - d. If the product does not operate normally by following the operating instructions. Adjust only those controls that are covered by the operating instructions as an improper adjustment of other controls may result in damage and will often require extensive work by a qualified technician to restore the product to its normal operation.
 - e. If the product has been dropped or damaged in any way.
 - f. When the product exhibits a distinct change in performance - this indicates a need for service.
19. Replacement Parts - When replacement parts are required, be sure the service technician has used replacement parts specified by the manufacturer or have the same characteristics as the original part. Unauthorized substitutions may result in fire, electric shock, or other hazards.
20. Safety Check - Upon completion of any service or repairs to this product, ask the service technician to perform safety checks to determine that the product is in proper operating condition.
21. Wall or ceiling Mounting - The product should be mounted to a wall or ceiling only as recommended by the manufacturer.
22. Heat - The product should be situated away from heat sources such as radiators. Heat registers, stoves, or other products (including amplifiers) that produce heat.

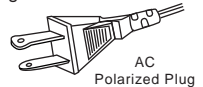

WARNING: Changes or modifications to this unit not expressly approved by the party responsible for compliance could void the user's authority to operate the equipment.

NOTE: This equipment has been tested and found to comply with the limits for a Class B digital device, pursuant to Part 15 of the FCC Rules. These limits are designed to provide reasonable protection against harmful interference in a residential installation. This equipment generates, uses, and can radiate radio frequency energy and, if not installed and used in accordance with the instructions, may cause harmful interference to radio communications. However, there is no guarantee that interference will not occur in a particular installation. If this equipment does cause harmful interference to radio or television reception, which can be determined by turning the equipment off and on, the user is encouraged to try to correct the interference by one or more of the following measures:

- Reorient or relocate the receiving antenna.
- Increase the separation between the equipment and receiver.
- Connect the equipment into an circuit different from that to which the receiver is connected.
- Consult the dealer or an experienced radio TV technician for help.

WARNING:

TO PREVENT FIRE OR SHOCK HAZARD, DO NOT EXPOSE THIS APPLIANCE TO RAIN OR MOISTURE. DO NOT REMOVE COVER. PILOT LAMPS SOLDERED IN PLACE. NO USER SERVICEABLE PARTS INSIDE. REFER SERVICING TO QUALIFIED SERVICE PERSONNEL.



The lightning flash with arrowhead symbol, within an equilateral triangle, is intended to alert user to the presence of uninsulated "dangerous voltage" within the product's enclosure that may be of sufficient magnitude to constitute risk of electric shock to persons.

CAUTION RISK OF ELECTRIC SHOCK DO NOT OPEN

CAUTION: TO REDUCE THE RISK OF ELECTRIC SHOCK, DO NOT REMOVE COVER (OR BACK). NO USER - SERVICEABLE PARTS INSIDE. REFER SERVICING TO QUALIFIED SERVICE PERSONNEL.



The exclamation point within an equilateral triangle is intended to alert user to the presence of important operating and maintenance (servicing) instruction in the literature accompanying the appliance.

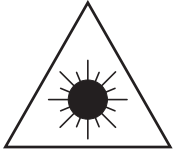

CAUTION

For Compact Disc Units Only:
INVISIBLE LASER RADIATION WHEN OPEN AND INTERLOCK FAILED OR DEFEATED. AVOID DIRECT EXPOSURE TO LASER BEAM.

Specification

Power Supply : AC 120V ~ 60Hz
Power Consumption : 15W
Speed : 33 /45 /78 RPM
Speaker : 3" x 5" Dynamic Type x 2

* DESIGN AND SPECIFICATIONS SUBJECT TO CHANGE WITHOUT NOTICE.

General

TROUBLESHOOTING

The unit will not operate.

- 1 Check that the unit is properly connected to an A/C outlet.
- 2 Check the ON/OFF VOLUME KNOB (11) to make sure it is on.

There is no sound

- 1 The volume has not been turned up.
- 2 Make sure the needle cover is flipped up.

Turntable is dragging

- 1 Make sure the Turntable Suspension Screws are turned clockwise all the way in to allow the turntable to sit on the suspension.

The Crosley Collegiate Stack-O-Matic™ Record Changer is equipped with a needle designed specifically to fit Crosley Stack-O-Matic™ Record Changers. Replacement needles (Model # NS1) are available for purchase through Crosley Radio at 1-866-CROSLEY. The NS1 model is not intended for use with other Crosley reproduction turntables.

www.crosleyradio.com

Turntable Operation

Turntable Features

- 1 Selectable 33/45/78 rpm speeds.
- 2 Load up to 6 records at a time.
- 3 Plays 7", 10", and 12" records.
- 4 Record changer is fully automatic or can be operated manually.
- 5 Adjustable tone control.

Turntable Instructions

- 1 Turn power on by rotating the ON/OFF VOLUME KNOB (11) clockwise.
- 2 Lift TENSION ARM (5) and rotate counter-clockwise over the TONE ARM (6).
- 3 Load desired records on the CENTER SPINDLE (2). Records should be loaded one at a time.
- 4 Lift TENSION ARM (5) and rotate it clockwise over the records and release. TENSION ARM (5) will automatically pull down onto the records.
- 5 Set the SIZE SELECT SWITCH (7) to the correct size of your records.
- 6 Set the SPEED SELECT SWITCH (4) to the correct speed of your records.
- 7 Move the TURNTABLE SWITCH (9) to the "ON" position. Turntable will begin to turn.
8. Flip the needle cover up.

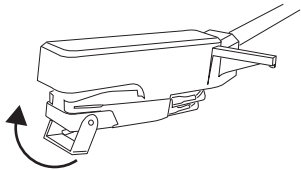

- 9 Move the TURNTABLE SWITCH (9) to "AUTO". The switch will automatically return back to the "ON" position and the first record will drop. The TONE ARM (6) will automatically lift and move to the beginning of the record. Once the first record is finished, the TONE ARM (6) will move back to the TONE ARM REST (8) and the next record will drop. The TONE ARM (6) will move back to the beginning of the record. This will repeat until the last record is finished. When the last record is finished, the TONE ARM (6) will return to its rest and the turntable will shut off.
- 10 To manually switch to the next record during playback, move the TURNTABLE SWITCH (9) to the "AUTO" position. The next record will drop and begin to play.
- 11 To stop playback manually, move the TURNTABLE SWITCH (9) to the "OFF" position. Gently lift the TONE ARM (6) from the record and return it to the TONE ARM REST (8).
- 12 To remove the records from the turntable, lift the TENSION ARM (5) up and rotate it counter-clockwise over the TONE ARM (6). Grab the edges of the bottom record and lift straight up.

Accessory: Adapter for 45 rpm

To play a 45rpm record, place the adapter in the center of the record. This unit includes six (6) adapters found in the bag with the instruction manual.

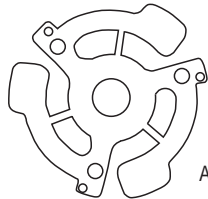

Adapter for 45 rpm

Tone Control

Use the Tone control to adjust the sound quality.

Welcome

Thank you for purchasing the Crosley 1960'S Stack-O-Matic Collegiate (CR85). Before operating this unit, please read this manual thoroughly and retain it for future reference.

About This Manual

Instructions in the manual describe the controls and functions of the CR85.

Table of Contents

Getting Started

Control Locator	4
Unpacking.....	5
Power Source.....	5

Turntable Operation

Turntable Features.....	6
Turntable Instructions.....	6
Accessory: Adapter for 45 rpm	6
Tone Control.....	6

General

Troubleshooting Guide.....	7
Warranty.....	8

Getting Started

Control Locator

1. TURNTABLE SUSPENSION SCREW
2. CENTER SPINDLE
3. TURNTABLE
4. SPEED SELECT SWITCH
5. TENSION ARM
6. TONE ARM
7. SIZE SELECT SWITCH
8. TONE ARM REST
9. TURNTABLE SWITCH
10. TONE CONTROL
11. ON/OFF VOLUME KNOB
12. AC POWER CORD

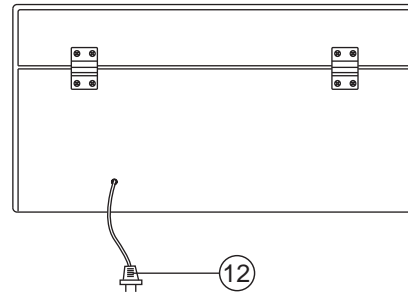
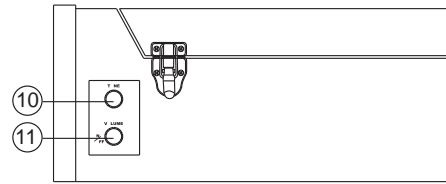
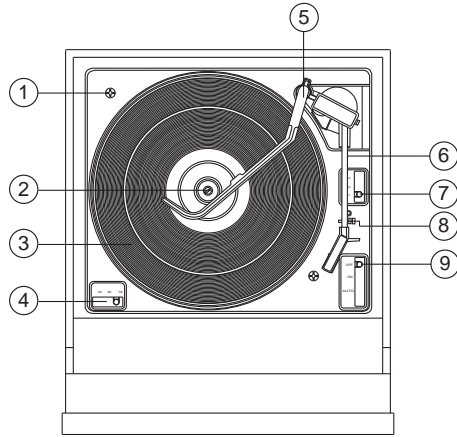

Getting Started

Unpacking

- 1 Remove packing materials from unit.
Note: Save all packing materials.
- 2 Remove plastic bag covering unit.
- 3 Remove plastic safety cover from A/C power cord (12).
- 4 Remove tie from A/C power cord.
- 5 Open lid and remove styrofoam shipping material from turntable.
- 6 Remove black tie-wrap from under the tone arm.
- 7 Using your Fingers, Turn the Turntable Suspension Screw (1) clockwise until it is all the way down. Do not force it. This allows turntable to float on its shock absorbers.



- 8 Gently pull out the rubber shipping pads.

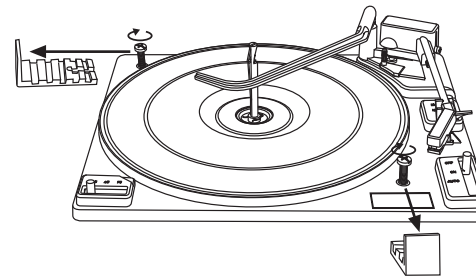

Power Source

- 1 Unwind the AC POWER CORD (12) at the back of the unit and connect it to a power outlet.
- 2 Plug A/C cord into appropriate outlet.

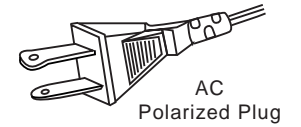

- 3 This product is equipped with a polarized alternating current line plug (a plug having one blade wider than the other). This plug will fit into the power outlet only one way. This is a safety feature. If you are unable to insert the plug fully into the outlet, try reversing the plug. If the plug should still fail to fit, contact your electrician to replace your obsolete outlet. Do not defeat the purpose of the polarized plug.